

## Circuit breaker with transient voltage suppressor

Datasheet – production data

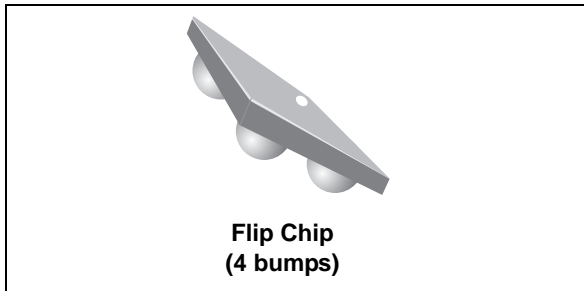

### Features

- Transient voltage suppressor (TVS)
- Non-resettable over current protection (OCP)
- Electrostatic discharge protection
- Electrical overstressed protection (OVP)
- Unidirectional device
- Low clamping factor  $V_{CL} / V_{BR}$
- Fast response time
- Very thin package: 0.5 mm

### Complies with the following standards:

- IEC 61000-4-2 level 4:
  - ±15 kV (air discharge)
  - ±8 kV (contact discharge)

### Description

The CBTVS2A16-1F3 is a single line diode TVS integrating a fuse designed specifically for the protection of integrated circuits in portable equipment and miniaturized electronic devices subject to ESD, OVP and OCP.

Figure 1. Pin configuration (bump side)

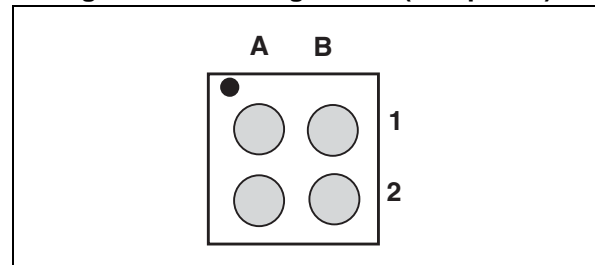
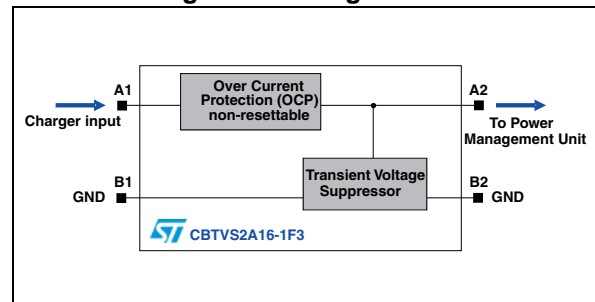

Figure 2. Configuration



1. B1 and B2 bumps must be grounded on the PCB together.

# 1 Characteristics

**Table 1. Absolute maximum ratings ( $T_{amb} = 25\text{ }^{\circ}\text{C}$ )**

Symbol	Parameter	Test condition	Value	Unit
$P_{PP}$	Peak pulse power dissipation (10/1000 $\mu\text{s}$ pulse) on A2-B2	$T_j \text{ initial} = T_{amb}$	70	W
	Peak pulse power dissipation (8/20 $\mu\text{s}$ pulse) on A2-B2		350	
$T_j$	Maximum operating junction temperature		125	$^{\circ}\text{C}$
$T_{stg}$	Storage temperature range		-55 to +150	$^{\circ}\text{C}$

**Figure 3. Electrical characteristics (definitions)**

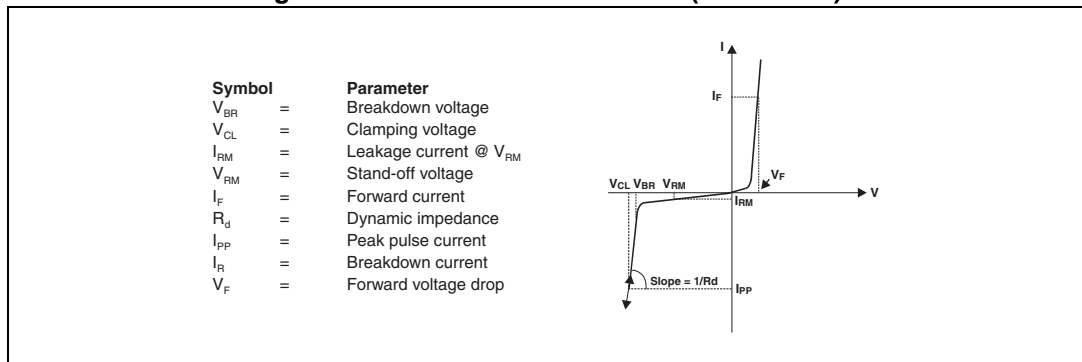

**Table 2. Electrical characteristics (at operating temperature:  $T_{op} = -30\text{ }^{\circ}\text{C}$  to  $+85\text{ }^{\circ}\text{C}$ , unless otherwise specified)**

Symbol	Test conditions	Min.	Typ.	Max.	Unit
$V_{BR}$	$I_R = 20\text{ mA}$	16			V
$I_{RM}$	$V_{RM} = 12\text{ V}$			100	nA
$V_{CL}$	$I_{PP} = 1\text{ A}$ , 8/20 $\mu\text{s}$ pulse waveform, between A1-B1			19	V
$V_F$	$I_F = 850\text{ mA}$ , between A1-B1			1.4	V
$T_{fuse2}$	At 3.2 A, A1-A2, A2-A1			24	hours
$C_{line}$	$V_R = 0\text{ V}$ , $V_{OSC} = 30\text{ mV}$ , $F = 1\text{ MHz}$		125		pF
$R_{A1-A2}$	At $T_{amb} = 25\text{ }^{\circ}\text{C}$ at 100 mA			50	m $\Omega$
$R_{A1-A2}$	After fused	1			M $\Omega$
$T_{Fuse}$	At 5 A (maximum opening time) A2-A1, A1-A2			100	ms
$T_{fuse\text{ Lifetime}}$	$I_{DC} = 2\text{ A}$ (continuous current) at $T_{amb} = 25\text{ }^{\circ}\text{C}$	1000			hours

Figure 4. Clamping voltage versus peak pulse current (typical values)

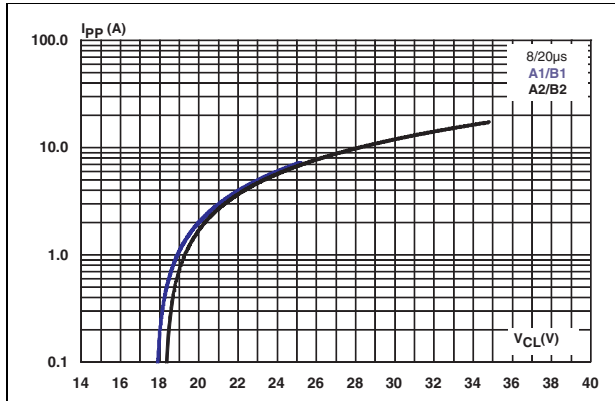

Figure 5. Forward voltage drop versus peak forward current (typical values)

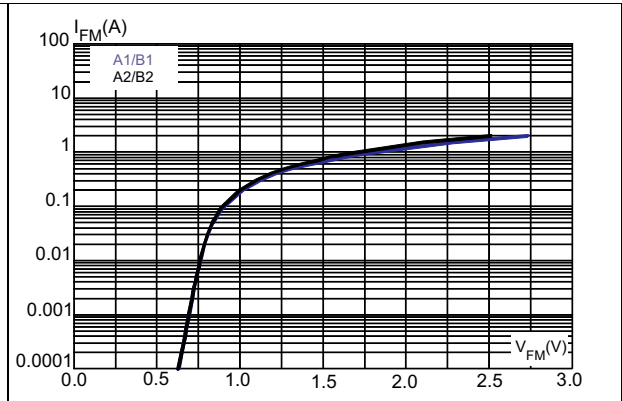

Figure 6. Frequency response

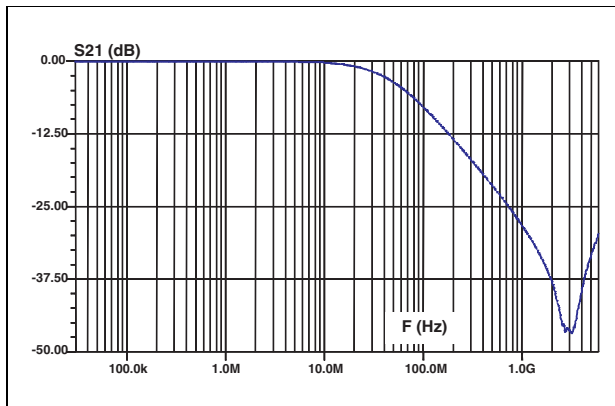

Figure 7. Junction capacitance versus reverse applied voltage (typical values)

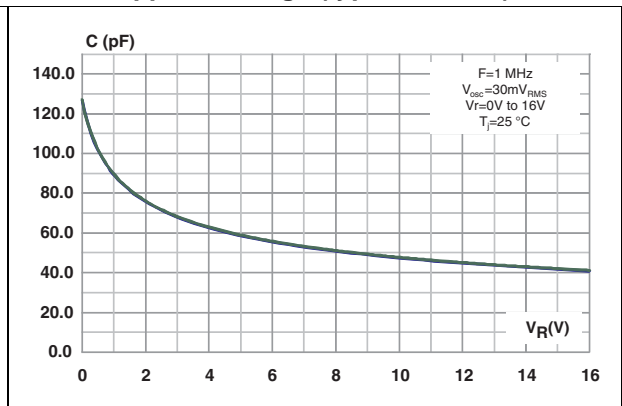

Figure 8. ESD response to IEC 61000-4-2 (+8 kV contact discharge)

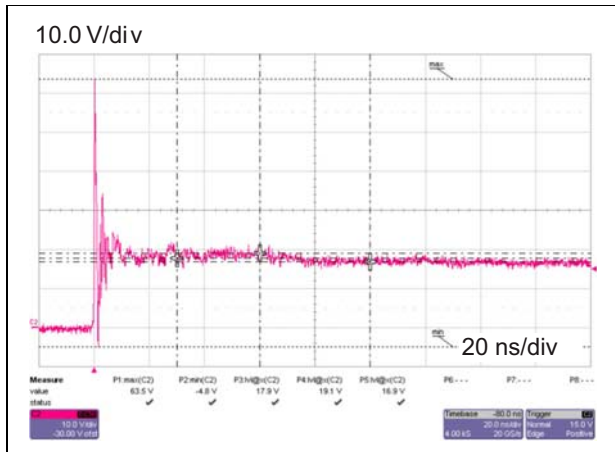
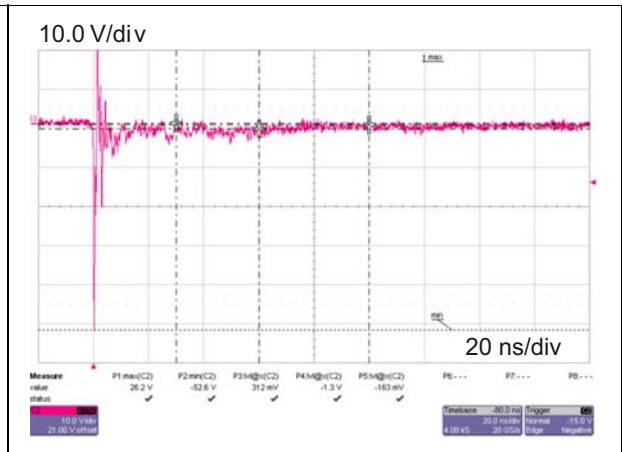

Figure 9. ESD response to IEC 61000-4-2 (-8 kV contact discharge)



## 2 Package information

In order to meet environmental requirements, ST offers these devices in different grades of ECOPACK<sup>®</sup> packages, depending on their level of environmental compliance. ECOPACK<sup>®</sup> specifications, grade definitions and product status are available at: [www.st.com](http://www.st.com). ECOPACK<sup>®</sup> is an ST trademark.

Figure 10. Package dimensions

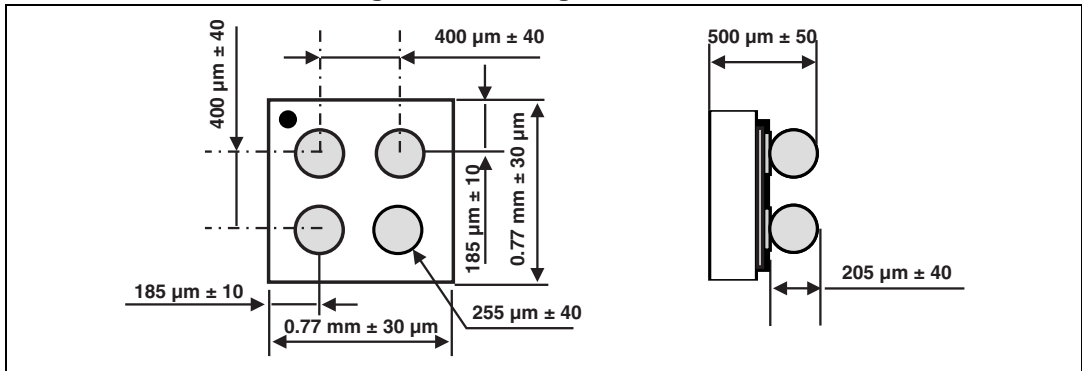

Figure 11. Foot print recommendations

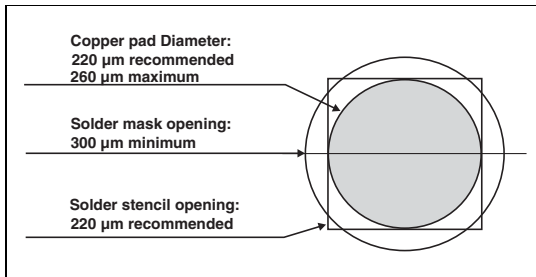

Figure 12. Marking

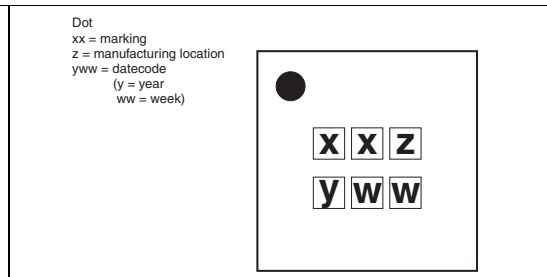
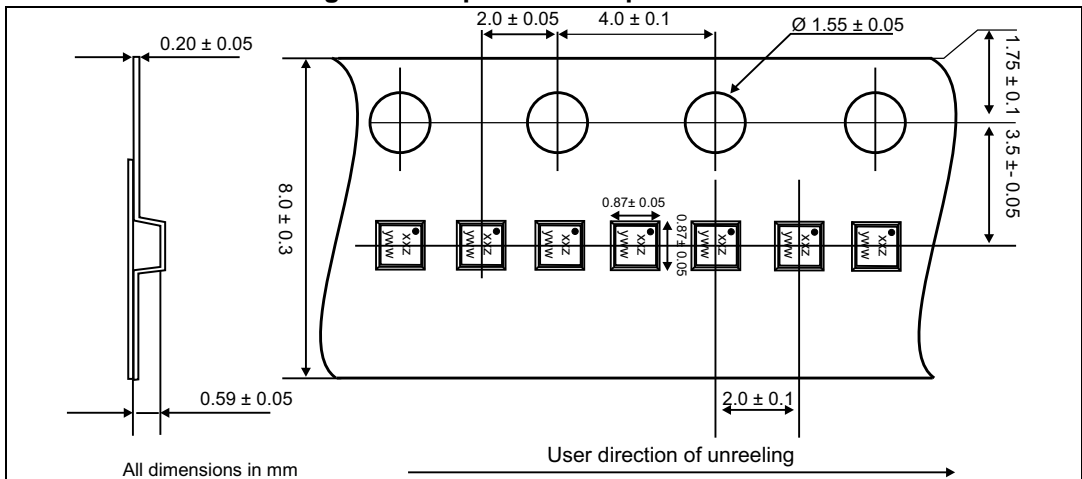

Figure 13. Tape and reel specifications



Note: More information is available in the application notes:  
 AN2348: "400  $\mu\text{m}$  Flip Chip: Package description and recommendations for use"  
 AN1751: "EMI Filters: Recommendations and measurements"

### 3 Ordering information

Figure 14. Ordering information scheme

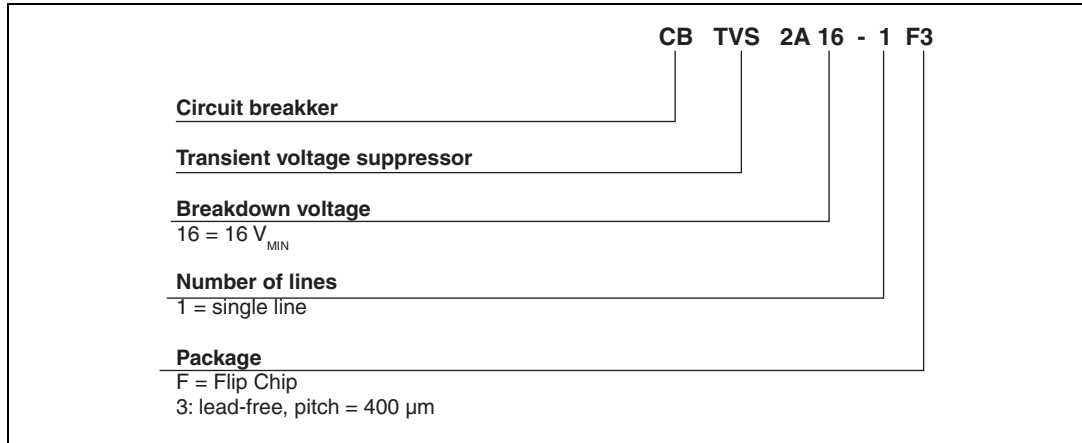

Table 3. Ordering information

Order code	Marking	Package	Weight	Base qty	Delivery mode
CBTVS2A16-1F3	ET	Flip Chip	0.659 mg	10 000	Tape and reel (7")

### 4 Revision history

Table 4. Document revision history

Date	Revision	Changes
01-Apr-2015	1	Initial release.

**IMPORTANT NOTICE – PLEASE READ CAREFULLY**

STMicroelectronics NV and its subsidiaries ("ST") reserve the right to make changes, corrections, enhancements, modifications, and improvements to ST products and/or to this document at any time without notice. Purchasers should obtain the latest relevant information on ST products before placing orders. ST products are sold pursuant to ST's terms and conditions of sale in place at the time of order acknowledgement.

Purchasers are solely responsible for the choice, selection, and use of ST products and ST assumes no liability for application assistance or the design of Purchasers' products.

No license, express or implied, to any intellectual property right is granted by ST herein.

Resale of ST products with provisions different from the information set forth herein shall void any warranty granted by ST for such product.

ST and the ST logo are trademarks of ST. All other product or service names are the property of their respective owners.

Information in this document supersedes and replaces information previously supplied in any prior versions of this document.

© 2015 STMicroelectronics – All rights reserved