

RF Power LDMOS Transistor

High Ruggedness N-Channel Enhancement-Mode Lateral MOSFET

Designed for mobile two-way radio applications with frequencies from 136 to 941 MHz. The high gain, ruggedness and wideband performance of this device make it ideal for large-signal, common-source amplifier applications in mobile radio equipment.

Narrowband Performance (12.5 Vdc, I_{DQ} = 100 mA, T_A = 25°C, CW)

Frequency (MHz)	G _{ps} (dB)	η _D (%)	P _{out} (W)
870 ⁽¹⁾	17.2	77.0	16

Wideband Performance (12.5 Vdc, T_A = 25°C, CW)

Frequency (MHz)	P _{in} (W)	G _{ps} (dB)	η _D (%)	P _{out} (W)
136-174	0.38	16.0	60.0	15
350-470	0.23	18.5	60.0	16
760-870 ⁽²⁾	0.32	16.8	52.3	15

Load Mismatch/Ruggedness

Frequency (MHz)	Signal Type	VSWR	P _{in} (W)	Test Voltage	Result
870 ⁽¹⁾	CW	> 65:1 at all Phase Angles	0.5 (3 dB Overdrive)	17	No Device Degradation

1. Measured in 870 MHz narrowband test circuit.
2. Measured in 760-870 MHz UHF broadband reference circuit.

Features

- Characterized for Operation from 136 to 941 MHz
- Unmatched Input and Output Allowing Wide Frequency Range Utilization
- Integrated ESD Protection
- Integrated Stability Enhancements
- Wideband — Full Power Across the Band
- Exceptional Thermal Performance
- Extreme Ruggedness
- High Linearity for: TETRA, SSB
- In Tape and Reel. T1 Suffix = 1,000 Units, 16 mm Tape Width, 7-inch Reel.

Typical Applications

- Output or Driver Stage VHF Band Mobile Radio
- Output or Driver Stage UHF Band Mobile Radio
- Output or Driver Stage for 700-800 MHz Mobile Radio

AFT09MS015NT1

**136-941 MHz, 16 W, 12.5 V
 WIDEBAND
 RF POWER LDMOS TRANSISTOR**

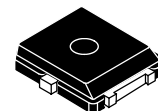

PLD-1.5W

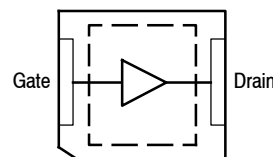

Note: The center pad on the backside of the package is the source terminal for the transistor.

Figure 1. Pin Connections

Table 1. Maximum Ratings

Rating	Symbol	Value	Unit
Drain-Source Voltage	V_{DSS}	-0.5, +40	Vdc
Gate-Source Voltage	V_{GS}	-6.0, +12	Vdc
Operating Voltage	V_{DD}	17, +0	Vdc
Storage Temperature Range	T_{stg}	-65 to +150	°C
Case Operating Temperature Range	T_C	-40 to +150	°C
Operating Junction Temperature (1,2)	T_J	-40 to +150	°C
Total Device Dissipation @ $T_C = 25^\circ\text{C}$ Derate above 25°C	P_D	125 1.0	W W/°C

Table 2. Thermal Characteristics

Characteristic	Symbol	Value (2,3)	Unit
Thermal Resistance, Junction to Case Case Temperature 85°C , 15 W CW, 12.5 Vdc, $I_{DQ} = 100$ mA, 870 MHz	$R_{\theta JC}$	1.0	°C/W

Table 3. ESD Protection Characteristics

Test Methodology	Class
Human Body Model (per JESD22-A114)	2, passes 2500 V
Machine Model (per EIA/JESD22-A115)	A, passes 150 V
Charge Device Model (per JESD22-C101)	IV, passes 2000 V

Table 4. Moisture Sensitivity Level

Test Methodology	Rating	Package Peak Temperature	Unit
Per JESD22-A113, IPC/JEDEC J-STD-020	3	260	°C

Table 5. Electrical Characteristics ($T_A = 25^\circ\text{C}$ unless otherwise noted)

Characteristic	Symbol	Min	Typ	Max	Unit
----------------	--------	-----	-----	-----	------

Off Characteristics

Zero Gate Voltage Drain Leakage Current ($V_{DS} = 40$ Vdc, $V_{GS} = 0$ Vdc)	I_{DSS}	—	—	10	μAdc
Zero Gate Voltage Drain Leakage Current ($V_{DS} = 12.5$ Vdc, $V_{GS} = 0$ Vdc)	I_{DSS}	—	—	2	μAdc
Gate-Source Leakage Current ($V_{GS} = 5$ Vdc, $V_{DS} = 0$ Vdc)	I_{GSS}	—	—	600	nAdc

On Characteristics

Gate Threshold Voltage ($V_{DS} = 10$ Vdc, $I_D = 78$ μAdc)	$V_{GS(th)}$	1.8	2.2	2.6	Vdc
Drain-Source On-Voltage ($V_{GS} = 10$ Vdc, $I_D = 0.78$ Adc)	$V_{DS(on)}$	—	0.15	—	Vdc
Forward Transconductance ($V_{DS} = 10$ Vdc, $I_D = 5.9$ Adc)	g_{fs}	—	4.4	—	S

Dynamic Characteristics

Reverse Transfer Capacitance ($V_{DS} = 12.5$ Vdc \pm 30 mV(rms)ac @ 1 MHz, $V_{GS} = 0$ Vdc)	C_{rss}	—	1.04	—	pF
Output Capacitance ($V_{DS} = 12.5$ Vdc \pm 30 mV(rms)ac @ 1 MHz, $V_{GS} = 0$ Vdc)	C_{oss}	—	34	—	pF
Input Capacitance ($V_{DS} = 12.5$ Vdc, $V_{GS} = 0$ Vdc \pm 30 mV(rms)ac @ 1 MHz)	C_{iss}	—	74	—	pF

1. Continuous use at maximum temperature will affect MTTF.
2. MTTF calculator available at <http://www.freescale.com/rf>. Select Software & Tools/Development Tools/Calculators to access MTTF calculators by product.
3. Refer to AN1955, *Thermal Measurement Methodology of RF Power Amplifiers*. Go to <http://www.freescale.com/rf>. Select Documentation/Application Notes - AN1955.

(continued)

Table 5. Electrical Characteristics ($T_A = 25^\circ\text{C}$ unless otherwise noted) **(continued)**

Characteristic	Symbol	Min	Typ	Max	Unit
----------------	--------	-----	-----	-----	------

Functional Tests (In Freescale Test Fixture, 50 ohm system) $V_{DD} = 12.5\text{ Vdc}$, $I_{DQ} = 100\text{ mA}$, $P_{in} = 0.3\text{ W}$, $f = 870\text{ MHz}$

Common-Source Amplifier Output Power	P_{out}	—	16.0	—	W
Drain Efficiency	η_D	—	77.0	—	%

Load Mismatch/Ruggedness (In Freescale Test Fixture, 50 ohm system) $I_{DQ} = 100\text{ mA}$

Frequency (MHz)	Signal Type	VSWR	P_{in} (W)	Test Voltage, V_{DD}	Result
870	CW	> 65:1 at all Phase Angles	0.5 (3 dB Overdrive)	17	No Device Degradation

TYPICAL CHARACTERISTICS

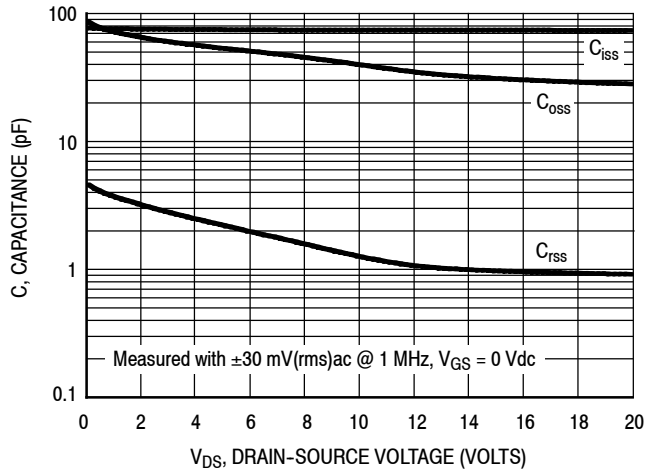
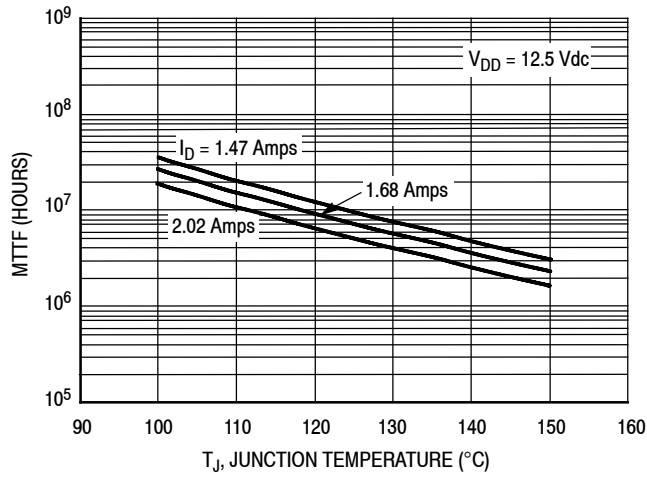

Figure 2. Capacitance versus Drain-Source Voltage



Note: MTTF value represents the total cumulative operating time under indicated test conditions.

MTTF calculator available at <http://www.freescale.com/rf>. Select Software & Tools/Development Tools/Calculators to access MTTF calculators by product.

Figure 3. MTTF versus Junction Temperature — CW

870 MHz NARROWBAND PRODUCTION TEST FIXTURE

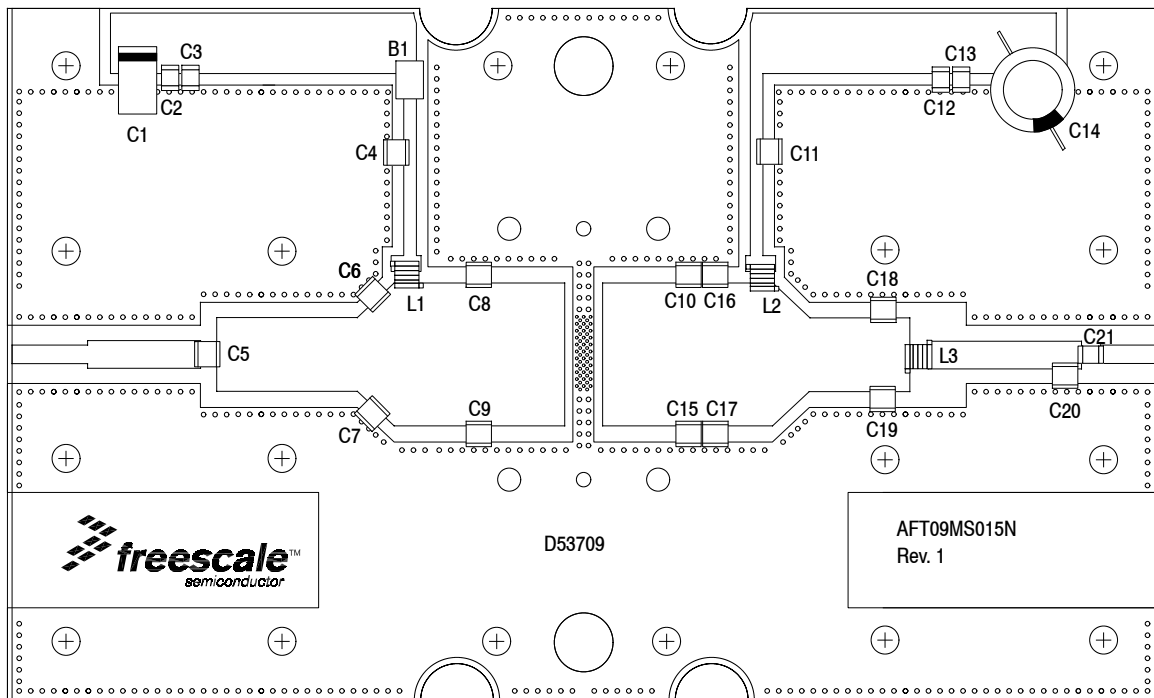

Figure 4. AFT09MS015NT1 Narrowband Test Circuit Component Layout — 870 MHz

Table 6. AFT09MS015NT1 Narrowband Test Circuit Component Designations and Values — 870 MHz

Part	Description	Part Number	Manufacturer
B1	RF Bead, Short	2743019447	Fair-Rite
C1	22 μ F, 35 V Tantalum Capacitor	T491X226K035AT	Kemet
C2, C13	0.1 μ F Chip Capacitors	CDR33BX104AKWS	AVX
C3, C12	0.01 μ F Chip Capacitors	C0805C103K5RAC	Kemet
C4, C11	56 pF Chip Capacitors	ATC100B560CT500XT	ATC
C5, C8, C9	5.6 pF Chip Capacitors	ATC100B5R6CT500XT	ATC
C6, C7	3.3 pF Chip Capacitors	ATC100B3R3CT500XT	ATC
C14	330 μ F, 35 V Electrolytic Capacitor	MCGPR35V337M10X16-RH	Multicomp
C15, C10	9.1 pF Chip Capacitors	ATC100B9R1CT500XT	ATC
C16, C17	7.5 pF Chip Capacitors	ATC100B7R5CT500XT	ATC
C18, C19	6.2 pF Chip Capacitors	ATC100B6R2BT500XT	ATC
C20	1.5 pF Chip Capacitor	ATC100B1R5BT500XT	ATC
C21	3.9 pF Chip Capacitor	ATC100B3R9CT500XT	ATC
L1	5.0 nH, 2 Turn Inductor	A02TKLC	Coilcraft
L2	8.0 nH, 3 Turn Inductor	A03TKLC	Coilcraft
L3	2.5 nH, 1 Turn Inductor	A01TKLC	Coilcraft
PCB	Rogers RO4350B, 0.030", $\epsilon_r = 3.66$	D53709	MTL

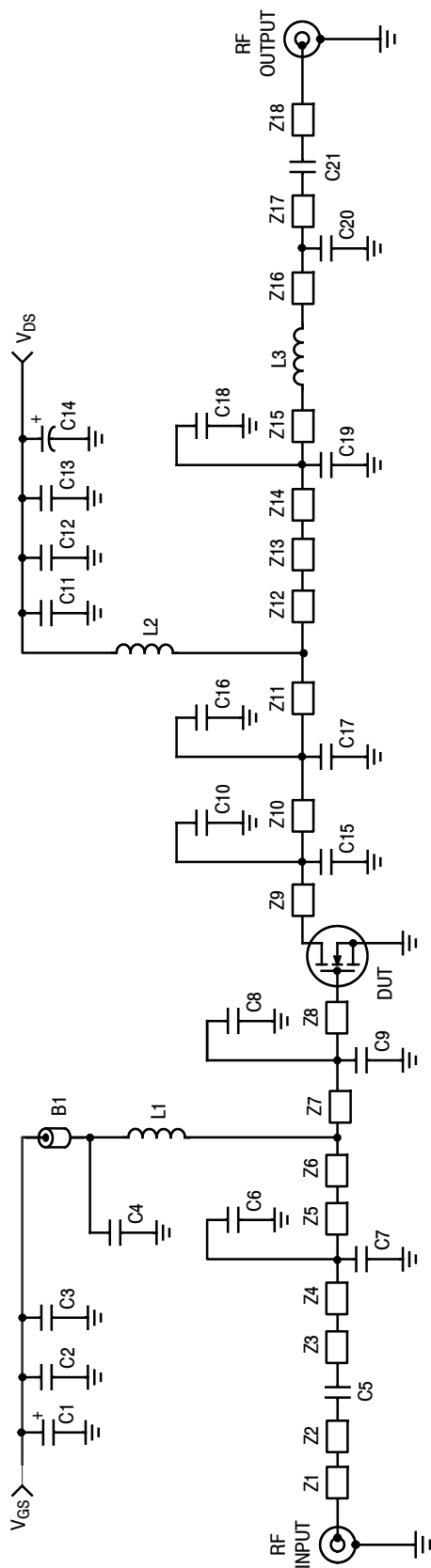

Figure 5. AFT09MS015NT1 Narrowband Test Circuit Schematic — 870 MHz

Table 7. AFT09MS015NT1 Narrowband Test Circuit Microstrips — 870 MHz

Microstrip	Description
Z1	0.328" x 0.080" Microstrip
Z2	0.490" x 0.120" Microstrip
Z3	0.610" x 0.320" Microstrip
Z4	0.107" x 0.320" x 0.466" Taper
Z5	0.082" x 0.466" x 0.620" Taper
Z6	0.070" x 0.620" Microstrip
Z7	0.300" x 0.620" Microstrip
Z8	0.370" x 0.620" Microstrip
Z9	0.375" x 0.620" Microstrip
Z10	0.120" x 0.620" Microstrip
Z11	0.198" x 0.320" Microstrip
Z12	0.044" x 0.320" Microstrip
Z13	0.159" x 0.620" x 0.320" Taper
Z14	0.320" x 0.320" Microstrip
Z15	0.113" x 0.320" Microstrip
Z16	0.599" x 0.120" Microstrip
Z17	0.071" x 0.120" Microstrip
Z18	0.238" x 0.080" Microstrip

TYPICAL CHARACTERISTICS — 870 MHz

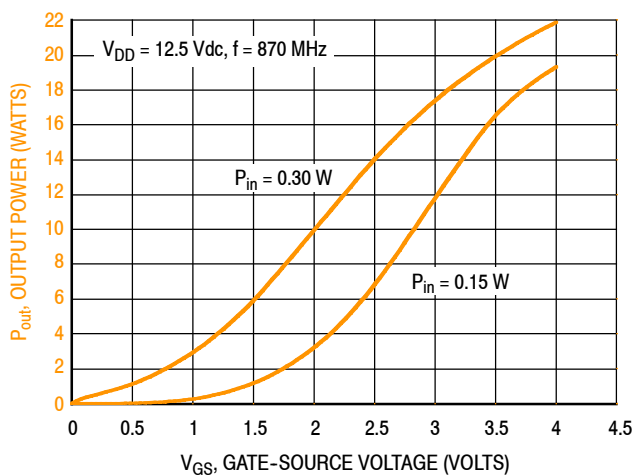

Figure 6. Output Power versus Gate-Source Voltage at a Constant Input Power

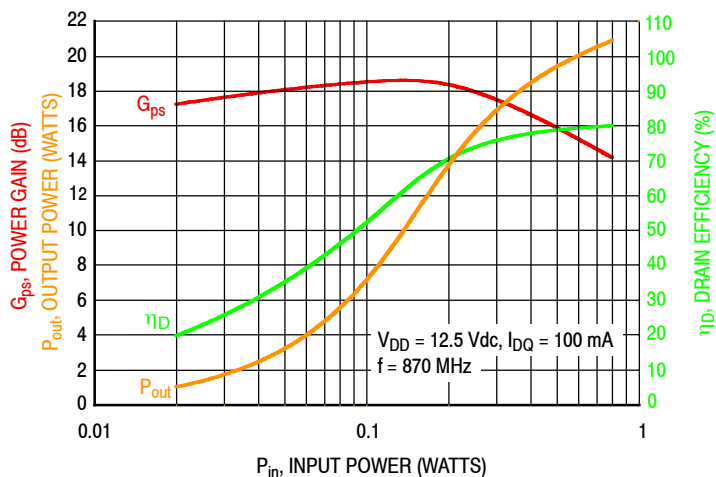

Figure 7. Power Gain, Output Power and Drain Efficiency versus Input Power

$V_{DD} = 12.5 \text{ Vdc}$, $I_{DQ} = 100 \text{ mA}$, $P_{out} = 15 \text{ W}$

f MHz	Z_{source} Ω	Z_{load} Ω
870	$0.80 + j0.80$	$2.05 + j1.80$

Z_{source} = Test circuit impedance as measured from gate to ground.

Z_{load} = Test circuit impedance as measured from drain to ground.

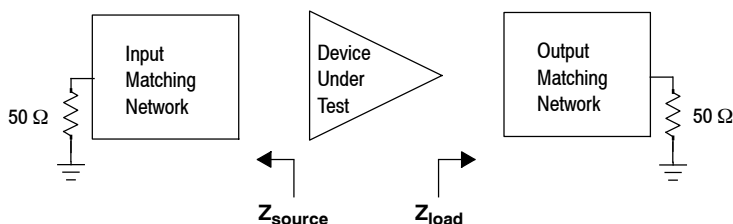

Figure 8. Narrowband Series Equivalent Source and Load Impedance — 870 MHz

760-870 MHz UHF BROADBAND REFERENCE CIRCUIT

Table 8. 760-870 MHz UHF Broadband Performance (In Freescale Reference Circuit, 50 ohm system)

$V_{DD} = 12.5$ Volts, $I_{DQ} = 100$ mA, $T_A = 25^\circ\text{C}$, CW

Frequency (MHz)	P_{in} (W)	G_{ps} (dB)	η_D (%)	P_{out} (W)
760	0.29	17.1	51.1	15.0
815	0.24	18.0	57.7	15.0
870	0.30	17.0	59.2	15.0

Table 9. Load Mismatch/Ruggedness (In Freescale Reference Circuit)

Frequency (MHz)	Signal Type	VSWR	P_{in} (W)	Test Voltage, V_{DD}	Result
815	CW	> 65:1 at all Phase Angles	0.64 (3 dB Overdrive)	15	No Device Degradation

760-870 MHz UHF BROADBAND REFERENCE CIRCUIT

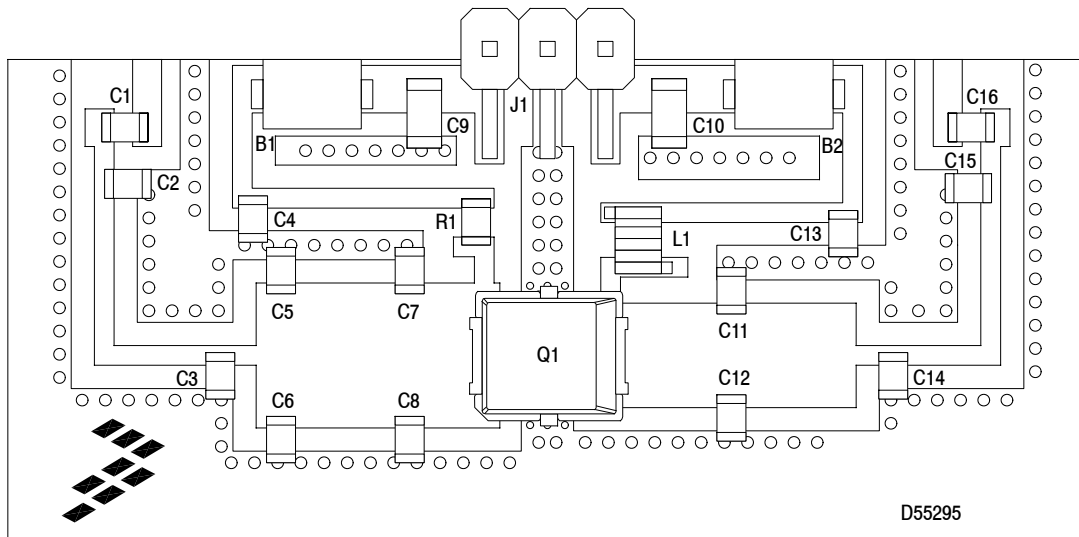

Figure 9. AFT09MS015NT1 UHF Broadband Reference Circuit Component Layout — 760-870 MHz

Table 10. AFT09MS015NT1 UHF Broadband Reference Circuit Component Designations and Values — 760-870 MHz

Part	Description	Part Number	Manufacturer
B1, B2	RF Beads	2743019447	Fair-Rite
C1, C5, C6, C7, C8	20 pF Chip Capacitors	GQM2195C2E200GB12D	Murata
C2	8.2 pF Chip Capacitor	GQM2195C2E8R2BB12D	Murata
C3	10 pF Chip Capacitor	GQM2195C2E100FB12D	Murata
C4, C13	56 pF Chip Capacitors	GQM2195C2E560GB12D	Murata
C9	1 μ F Chip Capacitor	GRM31MR71H105KA88L	Murata
C10	10 μ F Chip Capacitor	GRM31CR61H106KA12L	Murata
C11, C12	12 pF Chip Capacitors	GQM2195C2E120FB12D	Murata
C14, C15	5.6 pF Chip Capacitors	GQM2195C2E5R6BB12D	Murata
C16	100 pF Chip Capacitor	GQM2195C2E101GB12D	Murata
J1	Right-Angle Breakaway Headers (3 pins)	22-28-8360	Molex
L1	22 nH Air Core Inductor	0908SQ-22NJL	Coilcraft
Q1	RF Power LDMOS Transistor	AFT09MS015NT1	Freescale
R1	200 Ω , 1/8 W Chip Resistor	CRCW0805200RJNEA	Vishay
PCB	0.020", $\epsilon_r = 4.8$, FR4	D55295	MTL

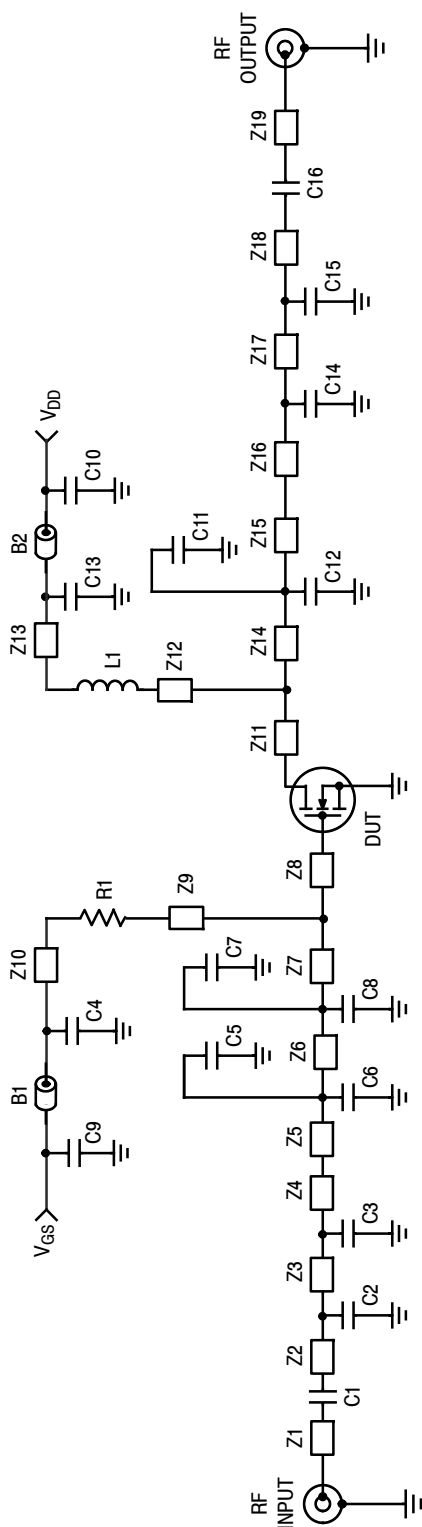

Figure 10. AFT09MS015NT1 UHF Broadband Reference Circuit Schematic — 760-870 MHz

Table 11. AFT09MS015NT1 Narrowband Test Circuit Microstrips — 760-870 MHz

Microstrip	Description
Z1	0.150" x 0.050" Microstrip
Z2	0.100" x 0.034" Microstrip
Z3	0.485" x 0.034" Microstrip
Z4	0.065" x 0.034" Microstrip
Z5	0.040" x 0.250" Microstrip
Z6	0.222" x 0.250" Microstrip
Z7	0.130" x 0.250" Microstrip
Z8	0.027" x 0.250" Microstrip
Z9	0.066" x 0.034" Microstrip
Z10	0.386" x 0.034" Microstrip
Z11	0.027" x 0.180" Microstrip
Z12	0.160" x 0.034" Microstrip
Z13	0.350" x 0.034" Microstrip
Z14	0.210" x 0.180" Microstrip
Z15	0.215" x 0.180" Microstrip
Z16	0.065" x 0.034" Microstrip
Z17	0.450" x 0.034" Microstrip
Z18	0.100" x 0.034" Microstrip
Z19	0.150" x 0.050" Microstrip

TYPICAL CHARACTERISTICS — 760-870 MHz UHF BROADBAND REFERENCE CIRCUIT

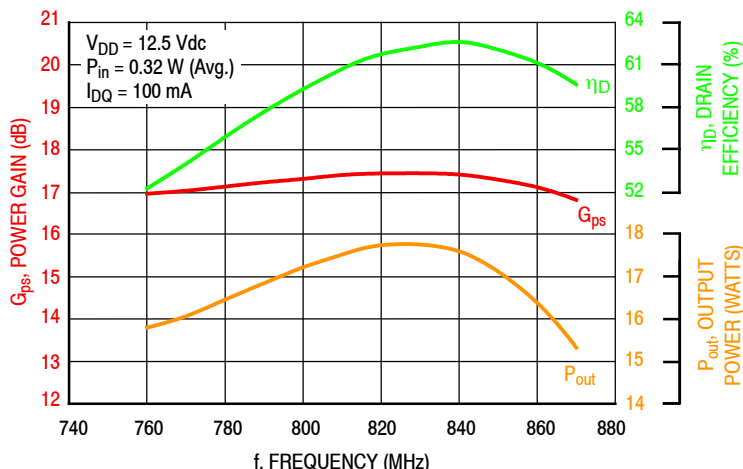

Figure 11. Power Gain, Drain Efficiency and Output Power versus Frequency at a Constant Input Power

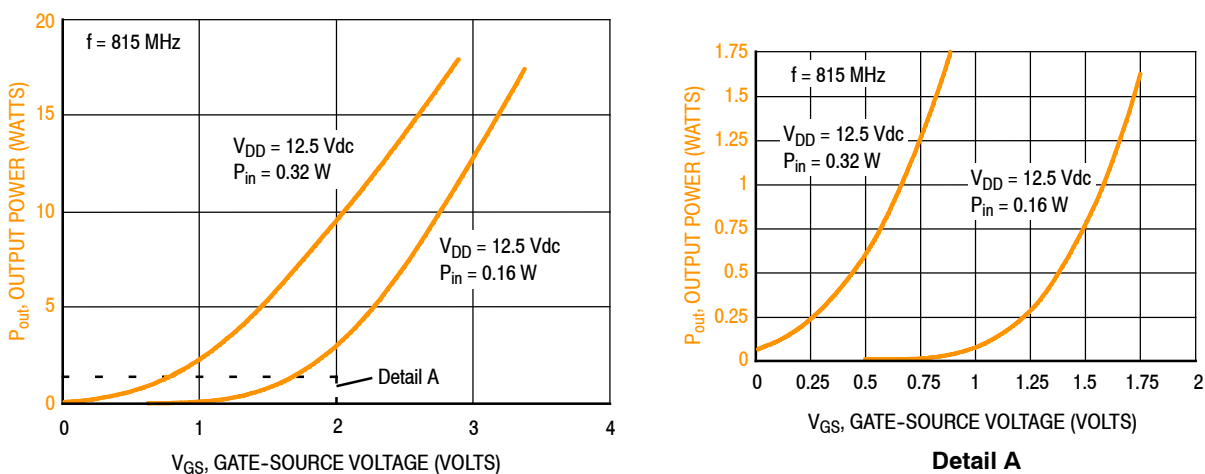

Figure 12. Output Power versus Gate-Source Voltage

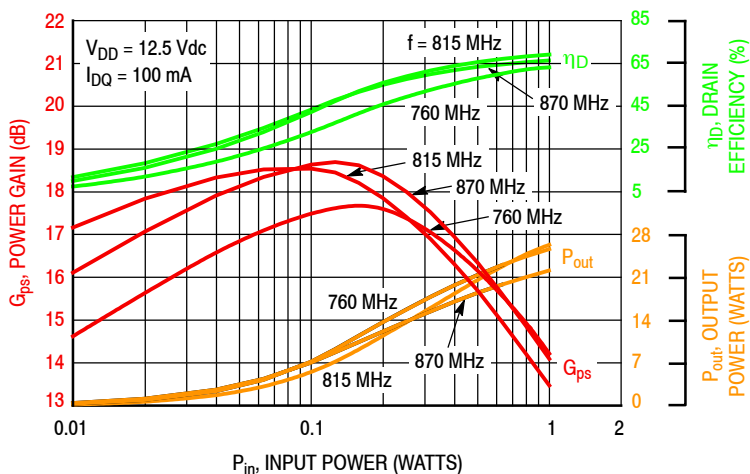
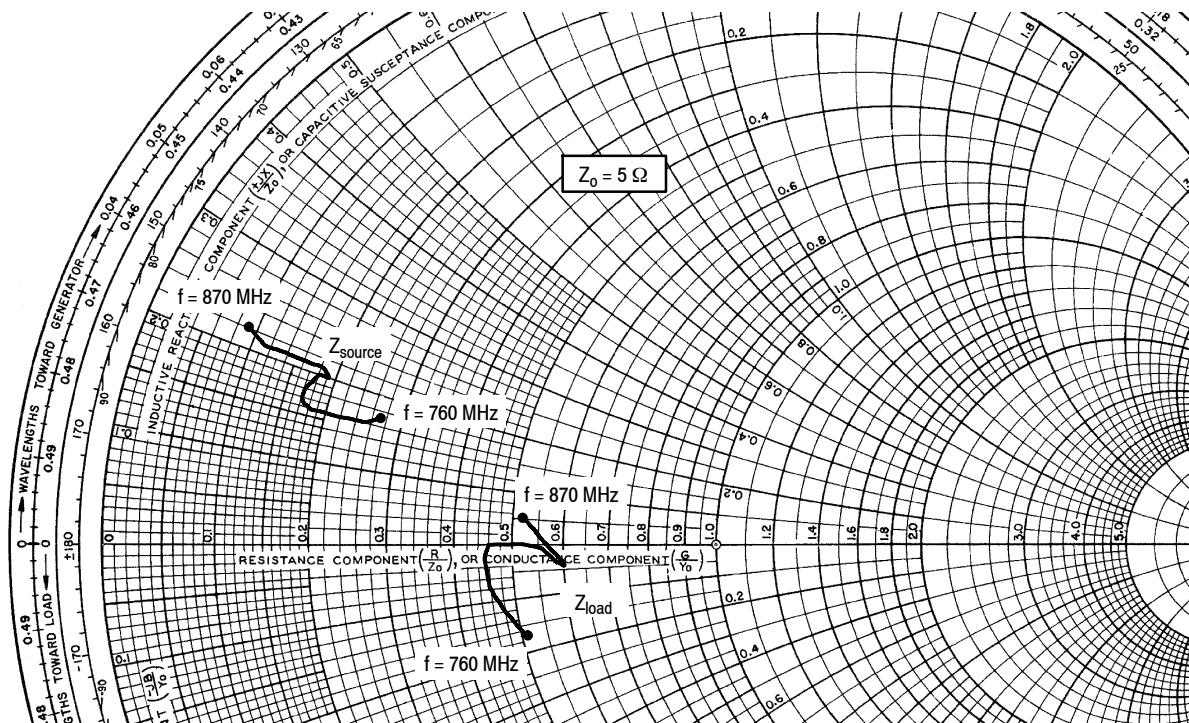

Figure 13. Power Gain, Drain Efficiency and Output Power versus Input Power and Frequency

760-870 MHz UHF BROADBAND REFERENCE CIRCUIT



$V_{DD} = 12.5 \text{ Vdc}$, $I_{DQ} = 100 \text{ mA}$, $P_{out} = 15 \text{ W}$

f MHz	Z_{source} Ω	Z_{load} Ω
760	$1.35 + j0.86$	$2.53 - j0.83$
770	$1.23 + j0.79$	$2.44 - j0.68$
780	$1.04 + j0.78$	$2.29 - j0.39$
790	$0.90 + j0.80$	$2.25 - j0.16$
800	$0.84 + j0.84$	$2.30 - j0.02$
810	$0.85 + j0.92$	$2.49 + j0.02$
820	$0.92 + j0.99$	$2.79 - j0.06$
830	$0.96 + j1.02$	$2.99 - j0.19$
840	$0.88 + j1.03$	$3.01 - j0.21$
850	$0.71 + j1.04$	$2.85 - j0.05$
860	$0.54 + j1.05$	$2.68 + j0.14$
870	$0.43 + j1.10$	$2.62 + j0.25$

Z_{source} = Test circuit impedance as measured from gate to ground.

Z_{load} = Test circuit impedance as measured from drain to ground.

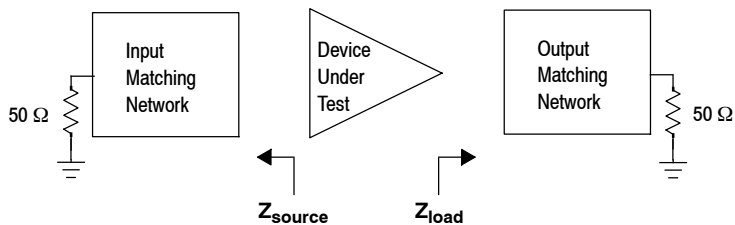

Figure 14. UHF Broadband Series Equivalent Source and Load Impedance — 760-870 MHz

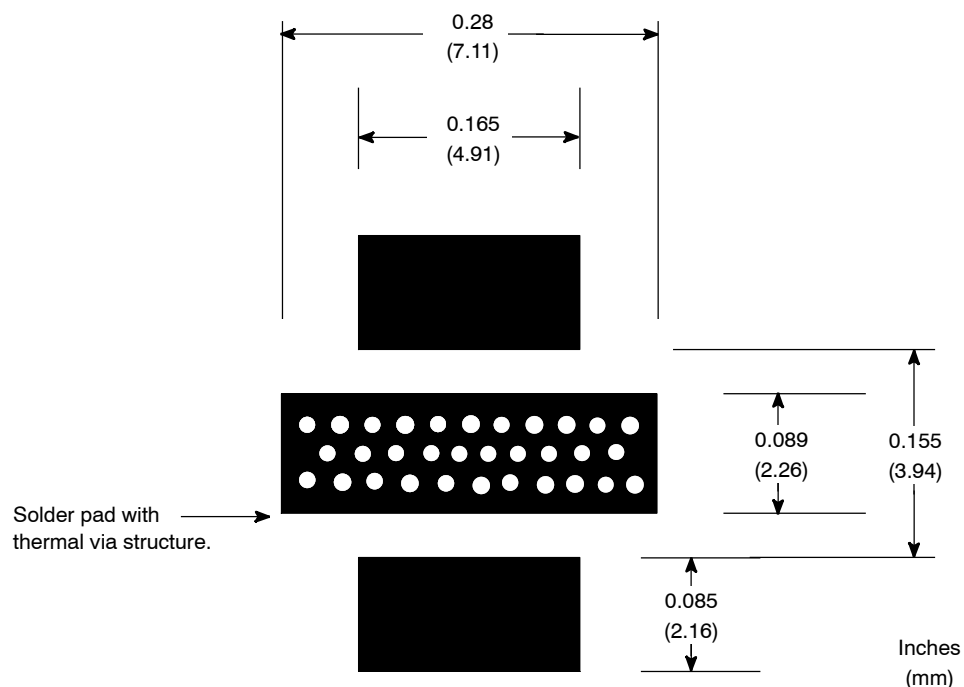

Figure 15. PCB Pad Layout for PLD-1.5W

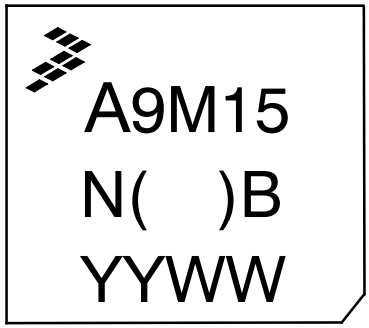
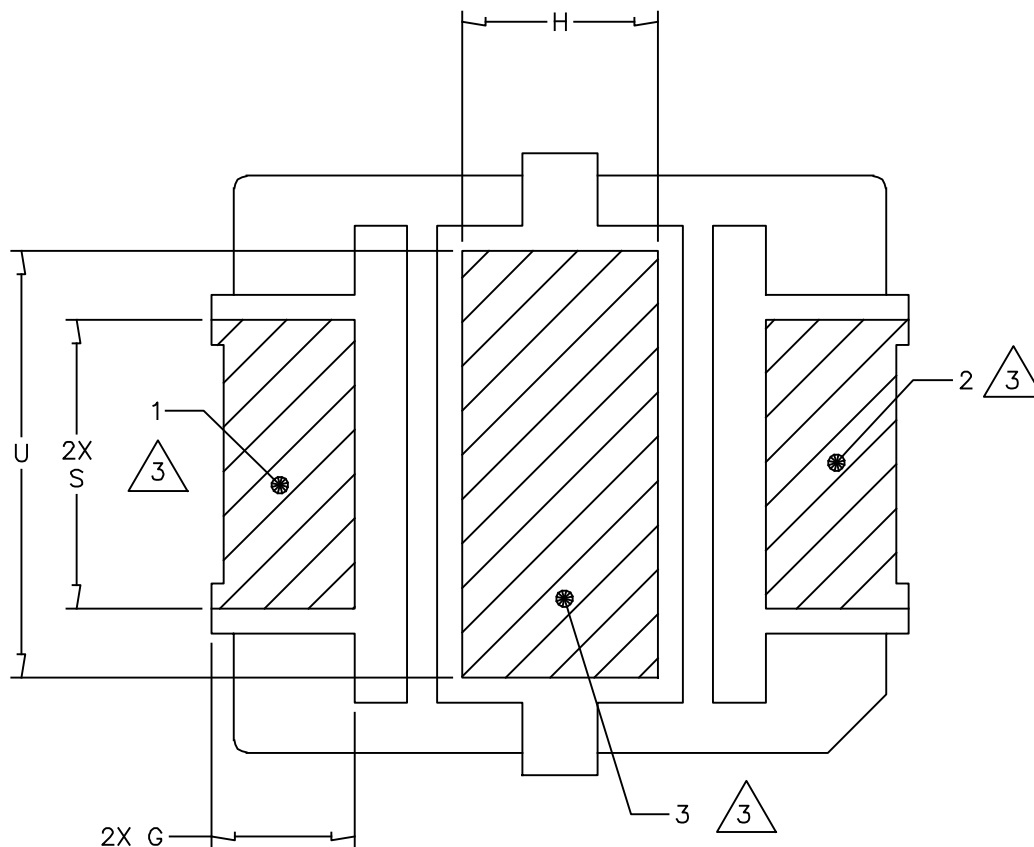

Figure 16. Product Marking



VIEW Y-Y

© FREESCALE SEMICONDUCTOR, INC. ALL RIGHTS RESERVED.	MECHANICAL OUTLINE	PRINT VERSION NOT TO SCALE	
TITLE: PLD-1.5W	DOCUMENT NO: 98ASA00476D	REV: 0	
	CASE NUMBER: 2297-01	14 JUN 2012	
	STANDARD: NON-JEDEC		

NOTES:

1. CONTROLLING DIMENSION: INCH.
2. INTERPRET DIMENSIONS AND TOLERANCES PER ASME Y14.5M-1994.

3. HATCHING REPRESENTS THE EXPOSED AND SOLDERABLE AREA. DIMENSIONS G, S, H AND U REPRESENT THE VALUES BETWEEN THE TWO OPPOSITE POINTS ALONG THE EDGES OF EXPOSED AREA.

4. THESE SURFACES ARE NOT PART OF THE SOLDERABLE SURFACES AND MAY REMAIN UNPLATED.

DIM	INCH		MILLIMETER		DIM	INCH		MILLIMETER	
	MIN	MAX	MIN	MAX		MIN	MAX	MIN	MAX
A	.255	.265	6.48	6.73	Q	.055	.063	1.40	1.60
B	.225	.235	5.72	5.97	R	.200	.210	5.08	5.33
C	.065	.072	1.65	1.83	S	.110	—	2.79	—
D	.130	.150	3.30	3.81	U	.156	—	3.96	—
E	.021	.026	0.53	0.66	aaa	.004		0.10	
F	.026	.044	0.66	1.12	bbb	.005		0.13	
G	.038	—	0.97	—					
H	.069	—	1.75	—					
J	.160	.180	4.06	4.57					
K	.273	.285	6.93	7.24					
L	.245	.255	6.22	6.48					
N	.230	.240	5.84	6.10					
P	.000	.008	0.00	0.20					
© FREESCALE SEMICONDUCTOR, INC. ALL RIGHTS RESERVED.			MECHANICAL OUTLINE			PRINT VERSION NOT TO SCALE			
TITLE: PLD-1.5W					DOCUMENT NO: 98ASA00476D			REV: 0	
					CASE NUMBER: 2297-01			14 JUN 2012	
					STANDARD: NON-JEDEC				

Refer to the following resources to aid your design process.

Application Notes

- AN1907: Solder Reflow Attach Method for High Power RF Devices in Over-Molded Plastic Packages
- AN1955: Thermal Measurement Methodology of RF Power Amplifiers

Engineering Bulletins

- EB212: Using Data Sheet Impedances for RF LDMOS Devices

Software

- Electromigration MTTF Calculator
- RF High Power Model
- .s2p File

Development Tools

- Printed Circuit Boards

For Software and Tools, do a Part Number search at <http://www.freescale.com>, and select the “Part Number” link. Go to the Software & Tools tab on the part’s Product Summary page to download the respective tool.

REVISION HISTORY

The following table summarizes revisions to this document.

Revision	Date	Description
0	Feb. 2014	<ul style="list-style-type: none"> • Initial Release of Data Sheet
1	July 2014	<ul style="list-style-type: none"> • Fig. 6, Output Power versus Gate-Source Voltage at a Constant Input Power: updated P_{in} values to reflect correct unit of measure, p. 7 • Fig. 8, Narrowband Series Equivalent Source and Load Impedance - 870 MHz: updated Z_{source} and Z_{load} values to match final data from product model, p. 7

How to Reach Us:

Home Page:
freescale.com

Web Support:
freescale.com/support

Information in this document is provided solely to enable system and software implementers to use Freescale products. There are no express or implied copyright licenses granted hereunder to design or fabricate any integrated circuits based on the information in this document.

Freescale reserves the right to make changes without further notice to any products herein. Freescale makes no warranty, representation, or guarantee regarding the suitability of its products for any particular purpose, nor does Freescale assume any liability arising out of the application or use of any product or circuit, and specifically disclaims any and all liability, including without limitation consequential or incidental damages. "Typical" parameters that may be provided in Freescale data sheets and/or specifications can and do vary in different applications, and actual performance may vary over time. All operating parameters, including "typicals," must be validated for each customer application by customer's technical experts. Freescale does not convey any license under its patent rights nor the rights of others. Freescale sells products pursuant to standard terms and conditions of sale, which can be found at the following address: freescale.com/SalesTermsandConditions.

Freescale and the Freescale logo are trademarks of Freescale Semiconductor, Inc., Reg. U.S. Pat. & Tm. Off. Airfast is a trademark of Freescale Semiconductor, Inc. All other product or service names are the property of their respective owners.

© 2014 Freescale Semiconductor, Inc.